





## Features

- Pure sin output wave, AVR mode,
- Wall mounted metal case,
- Synchronize with working mains voltage and frequency
- Automatic charger and inverter mode,
- Energy save mode,
- Many parameters to set in LCD user MENU.

## Photo



## Applications

		
<b>Heating systems</b>	<b>Gas and solar systems</b>	<b>Security systems</b>
		
<b>Emergency lighting</b>	<b>Home electronics</b>	<b>Home automations</b>

## Parametry techniczne

MODEL	IPS1000-SIN	IPS1600-SIN
Output power (apparent/active)	1000VA/1000W	1600VA/1600W
<b>INPUT</b>		
Input voltage	Rated: 230VAC Input voltage range: 156Vac – 294Vac	
Input frequency	50/60Hz ± 10% (autodect)	
<b>OUTPUT</b>		
Output voltage	Mains mode: 182Vac – 253Vac, Battery mode: 230Vac +/- 5%,	
Frequency	50/60Hz ± 1% (auto-detect)	
Output waveform	Mains mode: pure sin, Battery mode: pure sin,	
Transfer time	Max.: 10 ms	
Output sockets	CEE 7/3 2pcs ( Shucko)	
Efficiency	Mains mode: <95% Battery mode: <80%	
Power factor	1,0	
Loads	Resistance, inductive, capacitive, rectifiers	
Overload in mains mode	105% przez 300s, 110% przez 120s, 125% przez 60s, 150% przez 10s, przejście w tryb BYPASS	
Overload in battery mode	105% przez 300s, 110% przez 60s, 125% przez 10s, 150% przez 0,7s, wyłączenie przetwornicy	
<b>BATTERY</b>		
Battery type	Lead Acid VRLA voltage: 12V	Lead Acid VRLA voltage: 24V
Charger current	1 - 50A * (default 20A)	1 - 60A * (default 20A)
Charger current level	1,2,3,4,5,6,7,8,9,10,15,20,25,30,35,40A	1,2,3,4,5,6,7,8,9,10,15,20,25,30,35,40 A
Boost voltage	14,4V Vdc	28,8V Vdc
Float voltage	13,6Vdc	27,4Vdc
End of discharge voltage	10,2Vdc	20,4Vdc
Eod level	19,2-23Vdc	19,2-23Vdc
Batteries capacity:	1szt 12V 26...400Ah in 12V system	2szt 12V 18...400Ah in 24V system
Battery cabel lenght:	0,8m	0,8m
Przekrój przewodów bateryjnych:	6mm <sup>2</sup> , M10	6mm <sup>2</sup> , M10
<b>PROTECTINS</b>		
Full protections	Overcurrent, short circuit, temperaturę, overvoltage, low discharge, over charge	
<b>ENVIRONMENT</b>		
Humidity	20~90% RH @ 0~40°C (non-condensate)	
Noise	Regulated fan speed	
<b>DIMMENSIONS &amp; WEIGHT</b>		
Weight netto/brutto (kg)	14 / 14,6 kg	18 / 18,5 kg
Dimmensions width / depth / height (mm)	293 / 280 / 160	293 / 280 / 160
Package width / depth / height (mm)	370 / 355 / 235	370 / 355 / 235

\*best charger current is 0,1C<sub>20</sub> capacity.

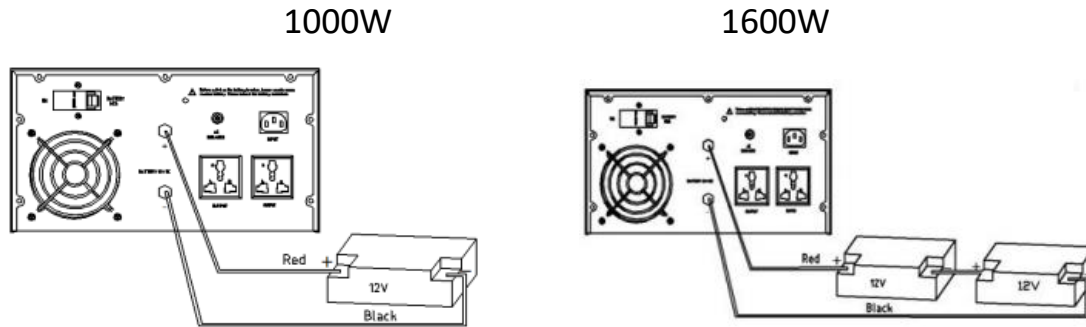

## Battery connection:



## Standard Accesories:

- instruction manual

## Additional accesories (options):

<p>- Akumulator AGM</p>  	<p>GLP 26-12 GLP 33-12 GLP 40-12 GLP 55-12 GLP 65-12 GLP 80-12 GLP 100-12 GLP 120-12 GLP 150-12 GLP 200-12</p>	<p>MB 26-12 MB 33-12 MB 40-12 MB 55-12 MB 65-12 MB 80-12 MB100-12 MB 120-12 MB 150-12 MB 200-12</p>	
---	--	---	---

MODEL	IPS1000-SIN	IPS1600-SIN
EAN	 5 902135 120927	 5 902135 123768

## Charger characteristic

3-stage charger : CC -> Boost CV -> Float.

- 1) Stage I – constant current, up to equalizing charge voltage
- 2) Stage II – constant voltage, time 10seconds
- 3) Stage III – floating voltage , after 10days recover

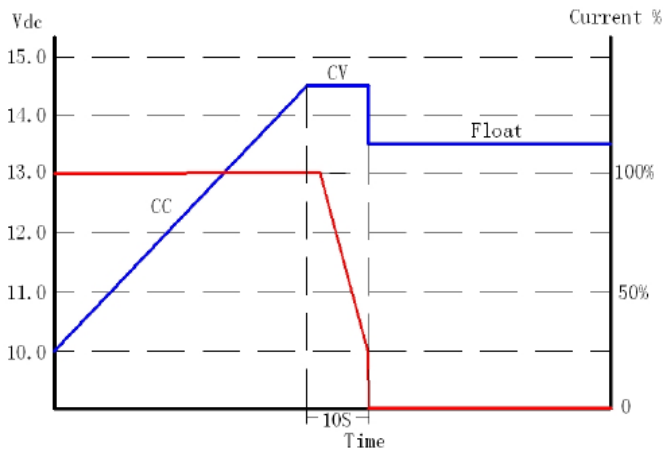

## LCD MENU function description:

	Function	Description	Default value	Options
1	OUT	Rated output voltage of the inverter	230V	220V/230V/240V
2	HZ	Rated output frequency of the inverter	50Hz	50Hz/60Hz
3	B	Equalizing charge voltage	14,1V	13,6...15V
4	F	Floating charge voltage	13,5V	13,2...14,6V
5	E	End of discharge voltage	10,2V	9,6...11,5V
6	CUR	Charging current	10A	1,2,3,4,5,6,7,8,9,10,15,20,25,30A 35,40A
7	IECO	Inverter no-load ECO mode	No	No/Yes N/Y
8	INLS	Inverter no-load shutdown function	No	No/Yes N/Y
9	DCAU	DC auto restart function	No	No/Yes N/Y
10	ACAU	AC self-starting function	Yes	No/Yes N/Y
11	INP	Input power matching of the generator	120%	10%-120% rated power
12	INLS	Inverter shutdown load rate	3%	3%-50% rated power
13	T	DC auto restart time	1h	0,5h...8h
14	SAVE	Save and exit	-	No/Yes N/Y